

合金贴片电阻承认书-RM2512 3W 系列

Approval Specification Metal Current Sensing Chip Resistors-Type **RM2512 3W**

1 范围 (scope) :

1.1 适用于本公司所生产的无铅、无卤之合金贴片电阻 RM2512 3W 系列

This specification applies to metal current sensing chip resistors which meet requirements of Pb free and halogen free.

2 产品料号 (part number) :

2512 3W 1% 5mΩ

RM2512FCR005GM

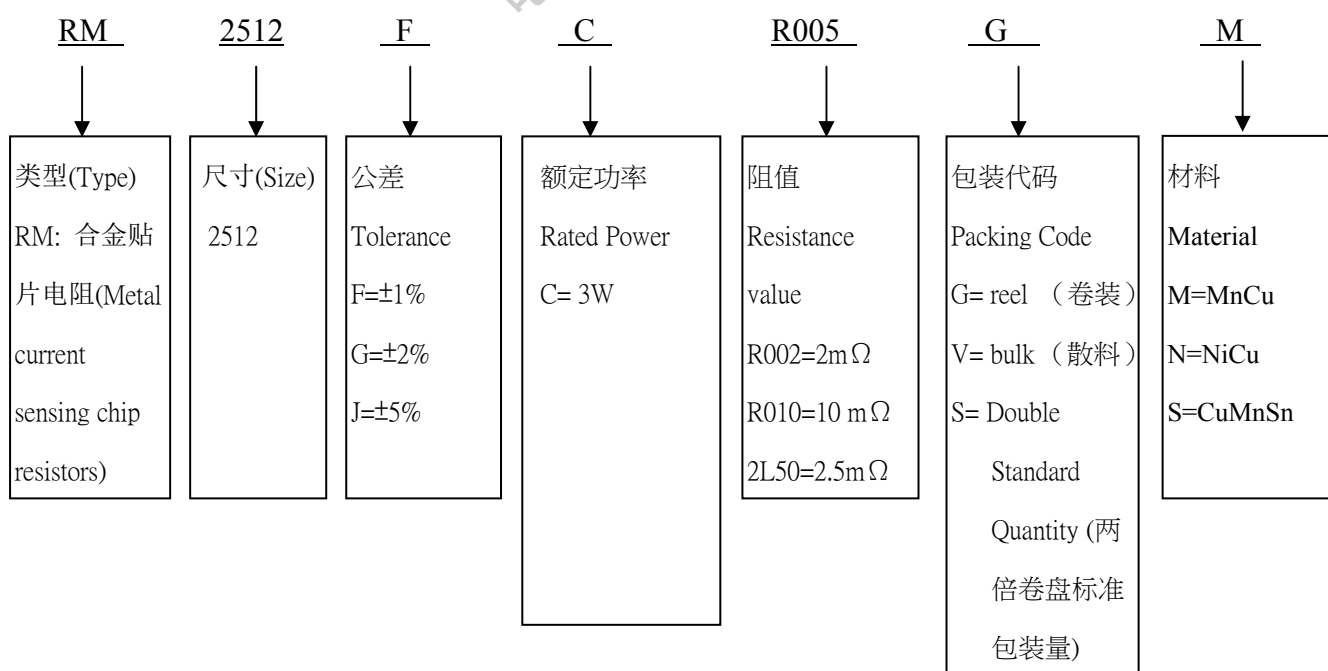

合金贴片电阻承认书-RM2512 3W 系列

Approval Specification Metal Current Sensing Chip Resistors-Type **RM2512 3W**

3 电阻本体字码标示(Marking on the Resistor's Body):

※ $\pm 1\%$, $\pm 2\%$, $\pm 5\%$ 的产品，以四字码标示，第一位字码 R 标示 10^{-3} ，后三位表示阻值的有效数字，第二位字码 L 表示阻值小数点。

$\pm 1\%$, $\pm 2\%$, $\pm 5\%$ tolerance product: the marking is 4 digits, The first letter 'R' denotes 10^{-3} , The other three digitals declare resistance. The second letter 'L' mean point.



3L50=3.5m Ω



R010=10m Ω

4 尺寸 (dimension) :

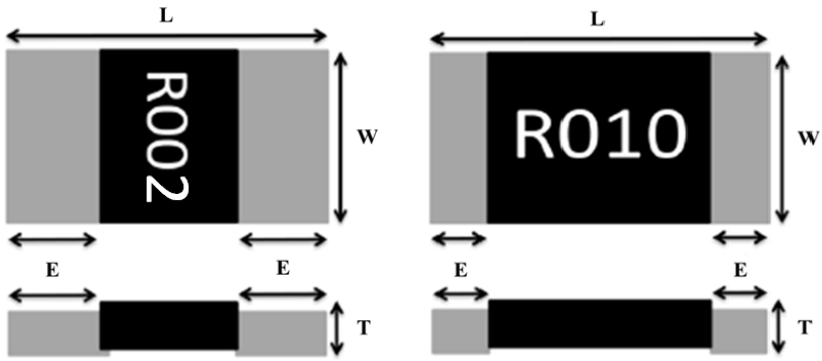
尺寸 dimension				
	单位 (unit) : mm			
型别 Type	L	W	T	E
RM2512	6.4 \pm 0.2	3.2 \pm 0.2	0.60 \pm 0.20	2.0 \pm 0.2 (R \leq 2m Ω)
				0.9 \pm 0.2 (R > 2m Ω)

合金贴片电阻承认书-RM2512 3W 系列

Approval Specification Metal Current Sensing Chip Resistors-Type **RM2512 3W**

5 功率衰减曲线 (Derating Curve) :

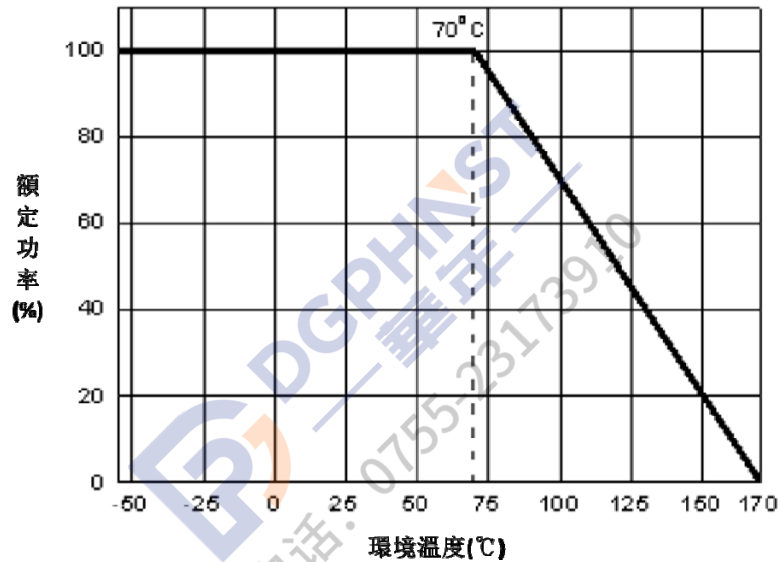

工作温度范围 (Operating Temperature Range) : $-55^{\circ}\text{C} \sim +170^{\circ}\text{C}$;

储存条件 (storage condition) : $5 \sim 35^{\circ}\text{C}$, 40~75%RH.

保存期限(Shelf Life): 2 年

合金贴片电阻承认书-RM2512 3W 系列

Approval Specification Metal Current Sensing Chip Resistors-Type **RM2512 3W**

6 电阻结构 (Construction) :

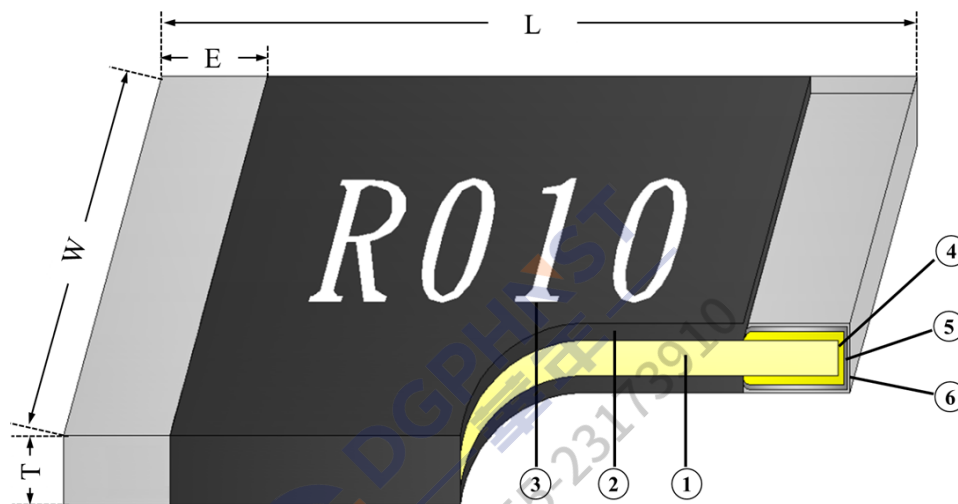

No.	结构 construction	主要材料 Major material
1	阻体 Resistive layer(Metal Alloy)	合金 Metal Alloy
2	保护层 Protective layer	环氧树脂 Epoxy
3	文字 Marking	环氧树脂 Epoxy
4	铜电极 Cu plating layer	铜 Cu
5	镍电极 Ni plating layer	镍 Ni
6	锡电极 Sn plating layer	锡 Sn

合金贴片电阻承认书-RM2512 3W 系列

Approval Specification Metal Current Sensing Chip Resistors-Type **RM2512 3W**

7 阻值范围及电气特性 (Resistance Range and Electrical Characteristics) :

型别 Type	额定功率 Rated Power	阻值范围 Resistance Range	温度特性TCR (ppm/°C)	绝缘阻抗 Insulation Resistance	操作温度 Operation Temperature
		F(±1%)、G(±2%)、J(±5%)			
RM2512	3W	1mΩ~10mΩ	±50	>100MΩ	-55°C~+170°C

备注 (remark) :

※ 额定电流计算公式 (The rated current is calculated by the following formula) :

$$I = \sqrt{P/R}$$

I : 额定电流 (Rated current) (A)

P : 额定功率 (Rated Power) (W)

R : 电阻阻值 (Resistance) (ohm)

※ 如果计算出的电流超过此型别的最大工作电流，则此型别的最大工作电流为此电阻的额定电流。

In case the value calculated by the formula exceed the maximum working current as above table, the maximum working current shall be regarded as rated current.

合金贴片电阻承认书-RM2512 3W 系列

Approval Specification Metal Current Sensing Chip Resistors-Type **RM2512 3W**

8 性能(Performance Specifications)

内容 Item	测试方法 Test Methods	测试条件 Test Conditions	规格 Specification
温度系数 Temperature Coefficient	IEC60115-1 4.8	$TCR = (R - R_0) / (t - t_0) R_0 \times 10^6 \text{ (ppm)}$ <p> R_0 电阻在室温下的阻值(resistance at room temperature) R 电阻在 125°C 下的阻值(resistance at 125°C) t_0 室温(room temperature) t 测试温度 (test temperature 125°C) </p>	参照规格表 As Spec.
高温储存 High Temperature Exposure	MIL-STD-202 Method 108	125°C 下放置 1000H，试验结束 24±4 小时后量测试验前后阻值变化率。 1000 hrs. @T=125°C. Measure the variation of resistance at 24±4 hours after test conclusion. $\Delta R\% = (R_2 - R_1) / R_1 * 100 \text{----- (\%)}$ <p> R_1 = 试验前阻值(resistance before test) R_2 = 试验后阻值(resistance after test) </p>	<±1%
低温储存 Low Temperature operation	IEC60115-1 4.23.4	-55°C 下放置 45 分钟，后量测试验前后阻值变化率。 45 min. @T=-55°C. Measure the variation of resistance after test conclusion. $\Delta R\% = (R_2 - R_1) / R_1 * 100 \text{----- (\%)}$ <p> R_1 = 试验前阻值(resistance before test) R_2 = 试验后阻值(resistance after test) </p>	<±1%
温度循环 Temperature cycling	JESD22 Method JA-104	-55°C & +125°C，循环 1000 次，试验结束 24±4 小时后量测试验前后阻值变化率。 1000Cycles (-55°C to +125°C) Measurement at 24±4 hours after test conclusion. Measure the variation of resistance at 24±4 hours after test conclusion. $\Delta R\% = (R_2 - R_1) / R_1 * 100 \text{----- (\%)}$ <p> R_1 = 试验前阻值(resistance before test) R_2 = 试验后阻值(resistance after test) </p>	<±1%

合金贴片电阻承认书-RM2512 3W 系列

Approval Specification Metal Current Sensing Chip Resistors-Type **RM2512 3W**

内容 Item	测试方法 Test Methods	测试条件 Test Conditions	规格 Specification
短时间过负荷 Short-time overload	IEC60115-1 4.13	加载 5 倍的额定功率，时间 5 秒后测量试验前后的阻值变化率。 Applied 5.0 times of rated power for 5 second. Measure the variation of resistance. $\Delta R\% = (R_2 - R_1) / R_1 * 100 \text{-----} (\%)$ R1 = 试验前阻值(resistance before test) R2 = 试验后阻值(resistance after test)	<±1%
耐湿特性 Biased Humidity	MIL-STD-202 METHOD 103	加载 10%额定功率，85℃/85%RH, 持续通电 1000H, 试验结束 24±4 小时后进行测试 1000 hours 85℃/85%RH. Note: Specified conditions: 10% of operating power. Measurement at 24±4 hours after test conclusion. $\Delta R\% = (R_2 - R_1) / R_1 * 100 \text{-----} (\%)$ R1 = 试验前阻值(resistance before test) R2 = 试验后阻值(resistance after test)	<±1%
负荷寿命 Operational life	MIL-STD-202 METHOD 108	电阻放入恒温箱中，温度 70±2℃，通电额定电流 1.5 小时，断电 0.5 小时；重复通断电至试验时间 1000 +48/-0 小时. 量测试验前后阻值变化率。 Put the specimen in a chamber at 70±2℃ temperature, and applied rated Current for 1.5H and rested for 0.5H repeatedly till total test time is 1000 +48/-0 .. Measure the variation of resistance. $\Delta R\% = (R_2 - R_1) / R_1 * 100 \text{-----} (\%)$ R1 = 试验前阻值(resistance before test) R2 = 试验后阻值(resistance after test)	<±2%

合金贴片电阻承认书-RM2512 3W 系列

Approval Specification Metal Current Sensing Chip Resistors-Type **RM2512 3W**

内容 Item	测试方法 Test Methods	测试条件 Test Conditions	规格 Specification
焊锡性 Solderability	J-STD-002B test B	沾助焊剂后浸入锡炉，锡炉温度 245±5℃，时间 2~3 秒 Dip the terminal in a flux and then dip into a soldering bath at 245±5℃ for 2~3sec.	最少 95%面积 上锡(Min 95% coverage)
抗焊锡热 Resistance to soldering heat	IEC60115-1 4.18	沾助焊剂后浸入锡炉，锡炉温度 260±5℃，时间 10±1 秒，测量试验前后的阻值变化率。 Dip the terminal in a flux and then dip into a soldering bath at 260±5℃ for 10±1sec. Measure the variation of resistance. $\Delta R\%=(R2-R1)/R1*100$ ----- (%) R1 = 试验前阻值(resistance before test) R2 = 试验后阻值(resistance after test)	<±0.5%
机械冲击 Mechanical Shock	MIL-STD-202 METHOD 213	半正弦，100g's，震動 6ms，速度 12.3 ft/s100Hz，量测试验前后阻值变化率。 100g's , Normal duration is 6ms , half sine shock pulse .Measure the variation of resistance. $\Delta R\%=(R2-R1)/R1 *100$ ----- (%) R1 = 试验前阻值(resistance before test) R2 = 试验后阻值(resistance after test)	<±0.5%
振动 Resistance to vibration	MIL-STD-202 METHOD 204	5g's 的力 20 分钟， 12 个循环，测试频率从 10-2000 赫兹，量测试验前后阻值变化率。 5g's for 20min.12cycles, 10-2000Hz . Measure the variation of resistance. $\Delta R\%=(R2-R1)/R1*100$ ----- (%) R1 = 试验前阻值(resistance before test) R2 = 试验后阻值(resistance after test)	<±0.5%

合金贴片电阻承认书-RM2512 3W 系列

Approval Specification Metal Current Sensing Chip Resistors-Type **RM2512 3W**

内容 Item	测试方法 Test Methods	测试条件 Test Conditions	规格 Specification
端子弯曲 Board Flex	AEC-Q200-005	弯曲 2mm，60 秒，量测试验前后阻值变化率。 Min 2mm deflection ,60sec. Measure the variation of resistance. Measure the variation of resistance.	<±0.5%
端子强度 Terminal Strength	AEC-Q200-006	应用 17.7N (1.8Kg)，时间 60±1 秒 Applied a 17.7N (1.8Kg) for 60±1seconds.	<±1%
冷热冲击 Thermal shock	MIL-STD-202 METHOD 107	温度-55/+125℃，周期数是 300,设备安装。最大传输时间是 20 秒，停留 15 分钟。 use -55/+125℃, Number of cycles is 300. Devices mounted. Maximum transfer time is 20 seconds. Dwell time is 15 minutes. Air –Air $\Delta R\%=(R2-R1)/R1*100----- (\%)$ R1 = 试验前阻值(resistance before test) R2 = 试验后阻值(resistance after test)	<±1%
易燃 Flammability	UL-94	V-0 or V-1 可接受的，电气特性测试不要求 V-0 or V-1are acceptable, Electrical test not required.	/
ESD 试验 ESD test	AEC-Q200-002	加载规定静电电压 2KV.2 次/间隔 1 秒， Other:2KV, 2times/1s	<±1%

合金贴片电阻承认书-RM2512 3W 系列

Approval Specification Metal Current Sensing Chip Resistors-Type **RM2512 3W**

9 包装规格 (Tapping Specification)

9.1 卷盘尺寸 (reel dimension)



尺寸 Dimensions		A	B	C	F	W
RM2512	mm	178±2.00	60.00±1.00	13.50±0.50	15.40±1.00	13.00±0.3
	Inch	7.008±0.079	2.362±0.039	0.531±0.020	0.606±0.039	0.512±0.012

※ 备注 (Remark) : (1) 2512 每卷 4,000 pcs

2512 Quantity per Reel 4,000 pcs/Reel

9.2 包装尺寸 (packing dimension)

單位:mm

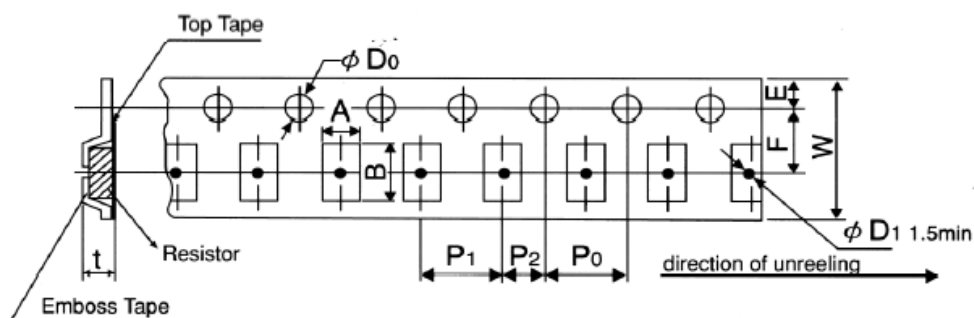

單位:mm

Packing	Type	A	B	W	F	E	P1	P2	P0	D0	T
Emboss	RM2512	3.6 ^{+0.2} _{-0.18}	6.9±0.2	12.0±0.2	5.5±0.05	1.75±0.1	4.0±0.1	2.0±0.05	4.0±0.05	1.50 ^{+0.1} _{-0.0}	1.00±0.15

10 上胶带剥离力测试 (Peel force of top cover tape)

上胶带以 300mm/分钟的速度，沿 165~180 度角的方向进行剥离，如下图所示。纸带的剥离力范围为 10g~70g; 载带的剥离力范围为 30~100g

The top cover tape is pulled at a speed of 300 mm/min with the angle between the tape during peel and the direction of unreeling maintained at 165 to 180 degree as following picture. The peel force of paper carrier tape shall be 0.1N to 0.7N(10 to 70 g), the peel force of plastic carrier tape shall be 0.3N to 1N (30 to 100 g)

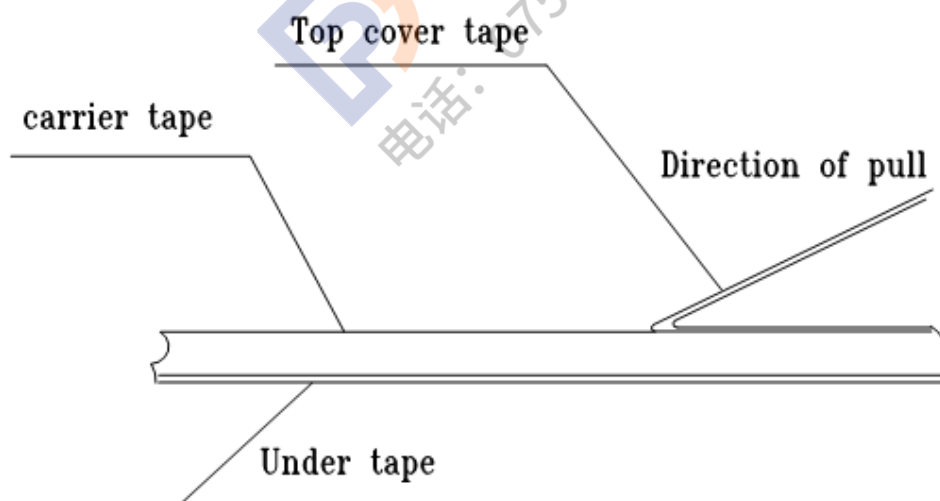

合金贴片电阻承认书-RM2512 3W 系列

Approval Specification Metal Current Sensing Chip Resistors-Type **RM2512 3W**

11 焊接 (soldering)

11.1 建议焊盘尺寸 (Recommended Solder Pad Dimension)

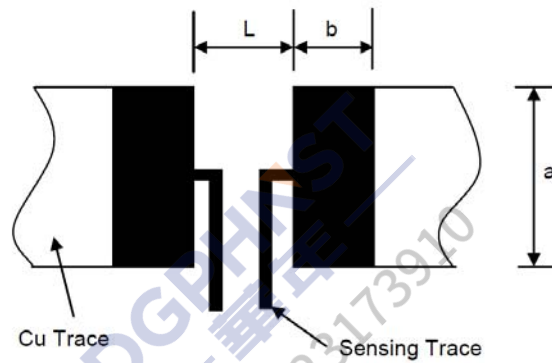

單位:mm

尺寸 Dimensions	阻值范围 Resistance Range	a	b	L
RM2512	1mΩ~2mΩ	4.00	3.10	1.80
	3mΩ~10mΩ	4.00	2.10	4.10

11.2 建议回流焊曲线 (Recommend reflow soldering profile)

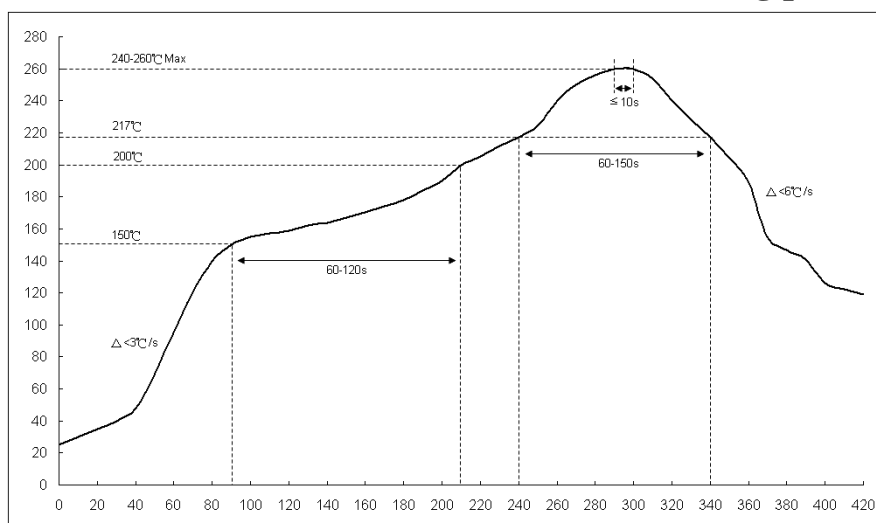

合金贴片电阻承认书-RM2512 3W 系列

Approval Specification Metal Current Sensing Chip Resistors-Type **RM2512 3W**

11.3 建议波峰焊曲线 (Recommend wave soldering profile)

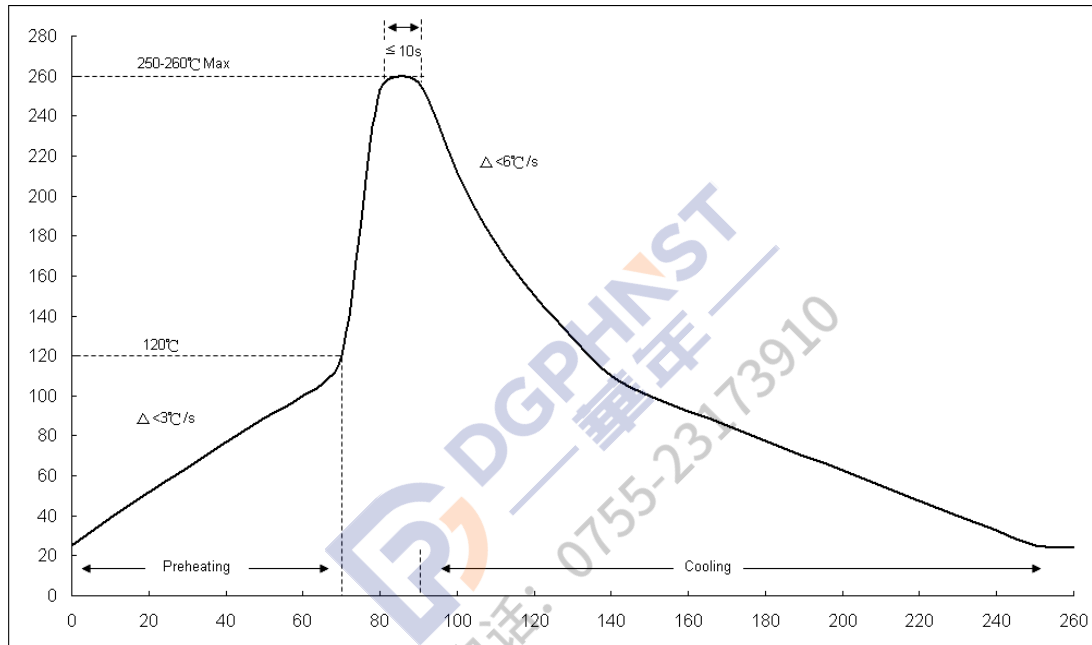

11.4 手工焊温度 (hand soldering temperature)

烙鐵溫度 $350 \pm 10^{\circ}\text{C}$ ，3 秒之內，避免烙鐵接觸電阻本體

The iron temperature is $350 \pm 10^{\circ}\text{C}$, hand soldering time less than 3S. Avoid solder iron tip direct touch the components body